

# **AC-800 A/C SERVICE STATION**

Service and support:

Tel: 443-380-0088

1-844-PROTEC9 (1844-776-8329)

**INDEX**

**SPECIFICATIONS-----2**

**FUNCTION TABLE-----3**

**PART DESCRIPTION-----4**

**FIRST OPERATION-----5**

**EQUIPMENT CONNECTION (For recovery/vacuum/oil injection/charge/Auto mode)-----7**

**RECOVERY-----8**

**VACUUM-----9**

**OIL INJECTION-----10**

**CHARGE-----11**

**AUTO. MODE-----12**

**HP LEAK TEST-----14**

**SYSTEM SETTING-----16**

**UPDATE-----20**

**MAINTENANCE REMINDING-----21**

**MAIN TROUBLESHOOTING-----22**

**Specifications:**

- **Dimension : Package 700\*630\*1230mm; Unpacked machine 635\*585\*1075mm**
- **Input power : AC220V±10%~50/60Hz , or AC110V±10%~60Hz**
- **Compressor power : 3/8HP**
- **Average gas state refrigerant recovery speed (through charge/suction port) : 0.25Kg/min.**
- **Hand valves free.**
- **Recovery rate: 99%, recovery to -0.5BAR.**
- **Pressurization to speed up old oil discharge.**
- **Vacuum pump capacity : 60L/min.**
- **TEKTINO individualized drier-filter capacity: 600ml**
- **Accuracy of gas cylinder load cell : ±10g**
- **Accuracy of oil bottle load cell : ±5g**
- **Gas cylinder capacity : 10KG Max.**
- **New/old oil bottle capacity : 330ml**
- **System Max. Pressure : 20bar**
- **Charge speed : 2Kg/Min(max.)**
- **LCD display : 105.5\*67.2mm, 480RGB x 272 Dots ,TFT full color**
- **High pressure gauge range : -1bar~3.5MPa**
- **Low pressure gauge range : -1bar~3.5MPa**
- **A/C database included, update through USB port.**
- **Automatic service reminding. The equipment provides 1200 operations totally (each recovery or vacuum counts for one operation) between regular maintenances. When 1200 operations have been made the machine automatically reminds to call distributor for service.**
- **Thermal printer**
- ***Optional: Refrigerant adding port for external gas cylinder. The recovery speed of liquid state refrigerant through this port: 0.35KG/min.***
- ***Optional: Condenser and cooling fan.***
- ***Optional: Vacuum leak test.***
- ***Optional: Heater band***
- ***Optional: Large capacity vacuum pump 120L/mn.***
- ***Optional: HP leak test at 2.0MPa.***

**Function Table**

<b>Main function</b>	<b>Recovery</b>	Recovers and purifies refrigerant from automotive A/C to equipment tank.
	<b>Vacuum</b>	Evacuates air and moisture from the A/C system. Automatic vacuum leak test (optional).
	<b>Oil injection</b>	Inject refrigeration oil to automotive A/C system. Can inject oil by setting volume manually, or automatically.
	<b>Charge</b>	Charge refrigerant from equipment gas cylinder to automotive A/C system
	<b>Auto. mode</b>	Performs the selected functions in a fully automatic sequence. The machine will stop automatically once all the selected functions have been completed
	<b>HP leak test</b>	Inject high pressure compressed N2 to auto A/C system, to detect leak location in auto A/C system.
<b>Sys. setting</b>	<b>Language</b>	Select operation language
	<b>Calibration</b>	Calibration refrigerant gas cylinder load cell and/or oil bottle load cell.
	<b>Air purge</b>	Purge non-condensable in equipment gas cylinder.
	<b>Database</b>	Enter automotive A/C database
	<b>Printer</b>	Test printer
	<b>Unit set</b>	Select metric or imperial units
	<b>Empty container weight set</b>	Set empty refrigerant gas cylinder or refrigeration oil containers weight.
<b>Component test</b>	Test work status of solenoids, vacuum pump and compressor.	

**Part description**

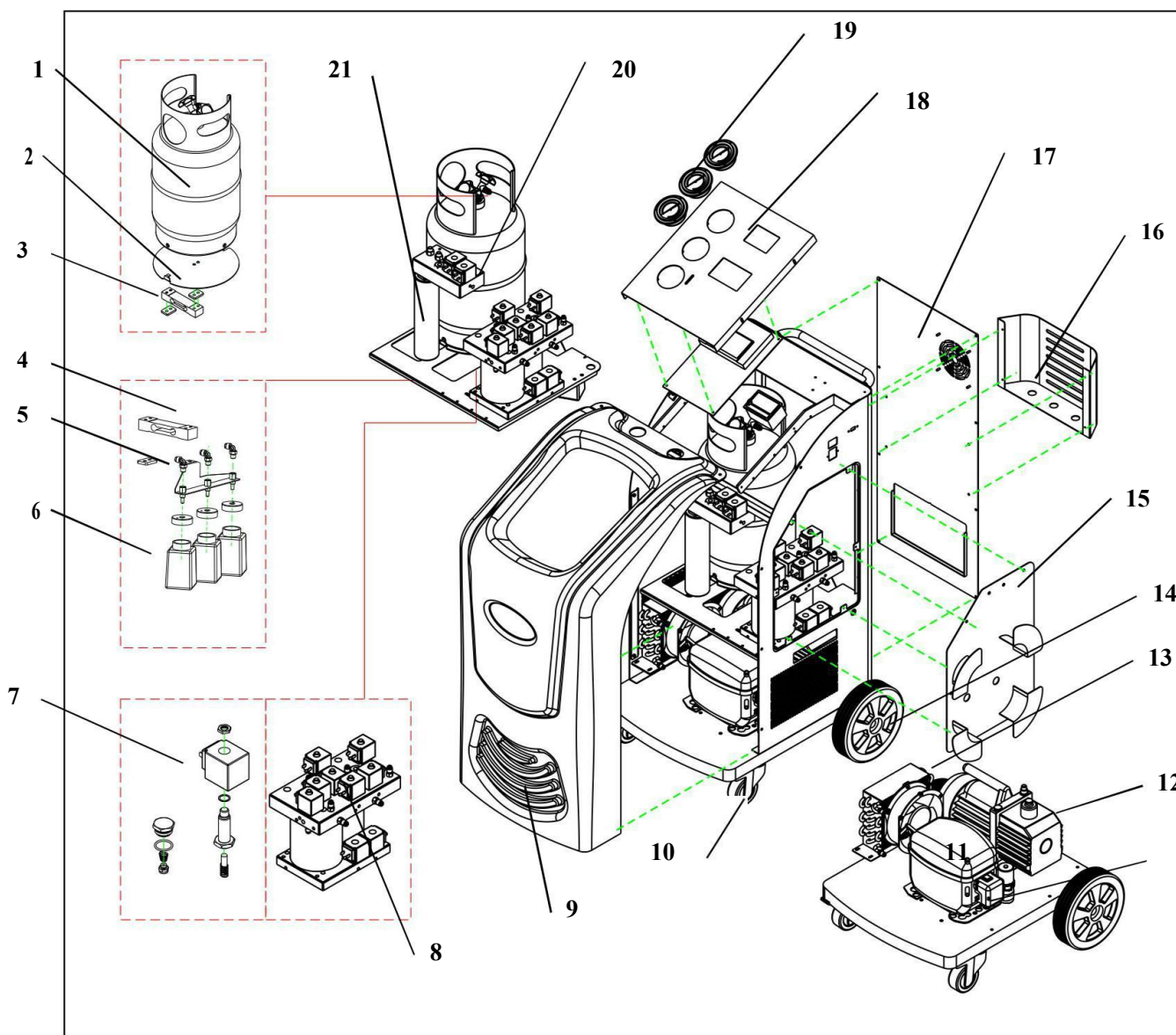

<b>1 ) Refrigerant gas cylinder</b>	<b>2 ) Gas cylinder support plate</b>	<b>3) Gas cylinder load cell</b>
<b>4 ) Oil bottle load cell</b>	<b>5 ) Oil bottle support</b>	<b>6 ) Oil bottles</b>
<b>7 ) Assembly of solenoid valve and check valve</b>	<b>8 ) Manifold assembly 1</b>	<b>9 ) front cover (plastic)</b>
<b>10) Front wheel</b>	<b>11 ) Compressor</b>	<b>12 ) Vacuum pump</b>
<b>13 ) Condenser and cooling fan (optional)</b>	<b>14 ) Rear wheel</b>	<b>15 ) Side cover</b>
<b>16 ) Accessory holder</b>	<b>17 ) Back cover</b>	<b>18 ) Upper cover</b>
<b>19 ) Pressure gauges</b>	<b>20 ) Manifold 2</b>	<b>21) Drier-filter</b>

## FIRST OPERATION

- **Unlock load cells (Remove the protection materials for transportation, in equipment side you can find same sticker).**

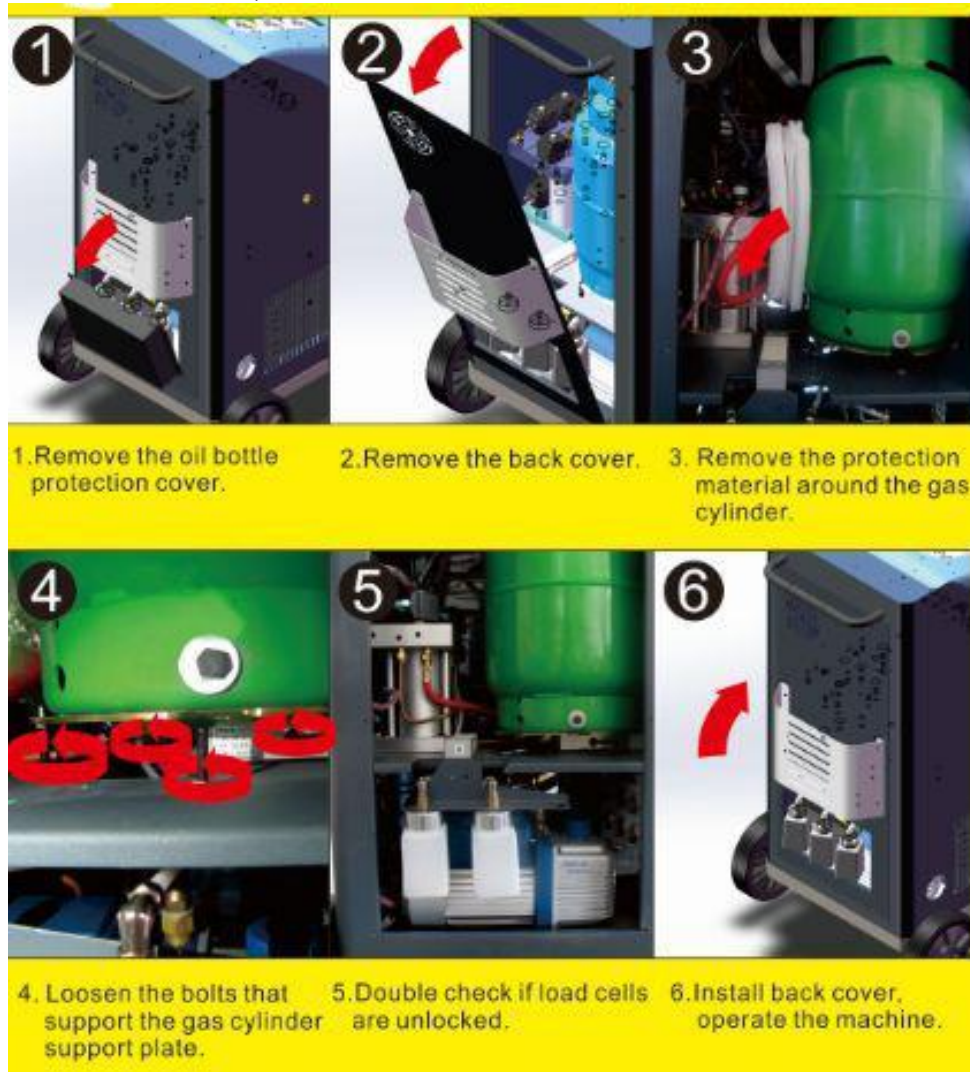

- **Fill equipment with refrigerant (New equipment is empty, you need to fill the equipment with refrigerant and refrigeration oil)**



**2. Open external tank valve. Run recovery.**

**1.Connect equipment either CHARGE or SUCTION port to an external tank with refrigerant, block other port of the equipment. You can also put the external upside down.**



**3. When total refrigerant in equipment reaches 2-9KG, close the external tank valve, wait for the equipment to stop recovering automatically.**

**Equipment Connection (For recovery/vacuum/oil injection/charge/Auto. Mode)**

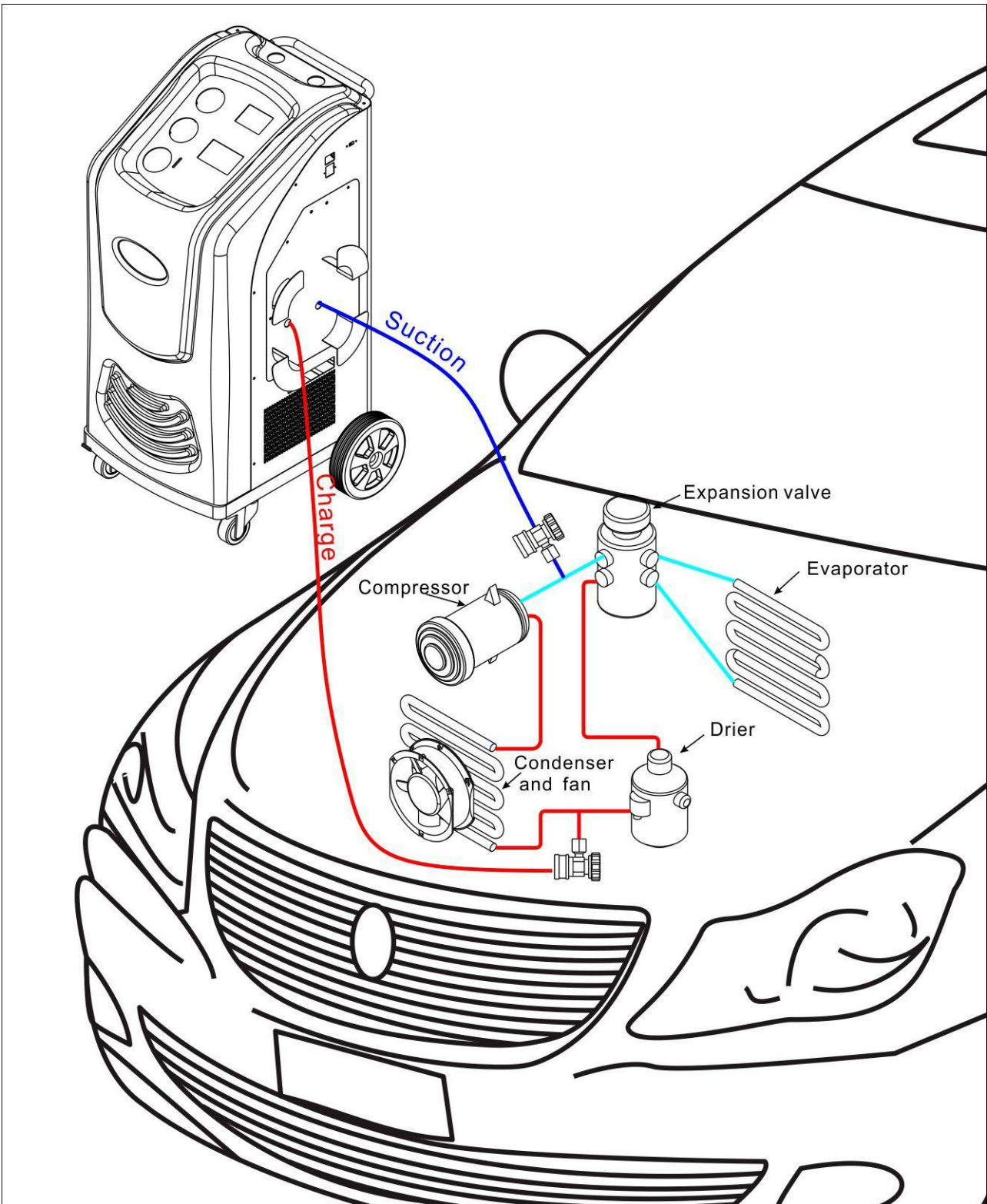

**Warning:** Except the situations clearly stated in the manual, during all equipment operations, please maintain the vehicle engine and A/C switched off, otherwise unexpected damages may be caused.

**Remarks:** HP leak test equipment connection is different, please refer to "HP leak test" chapter in this manual.

# Recovery

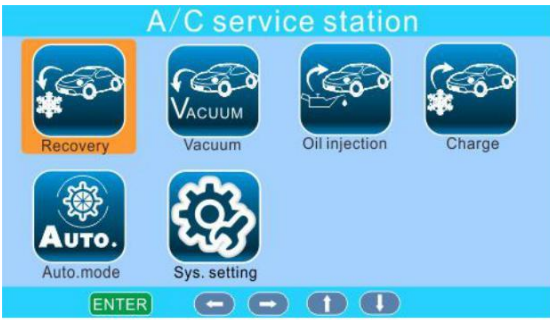

Remarks: With HP leak test function, this interface is different.  
Please refer to HP leak test function in this manual

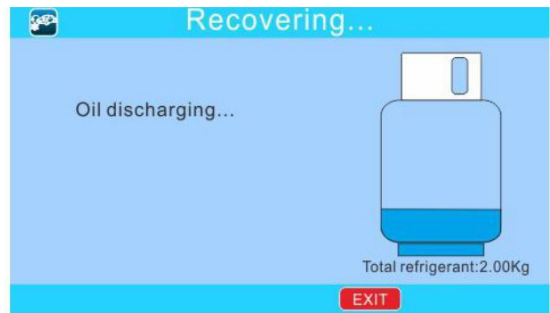
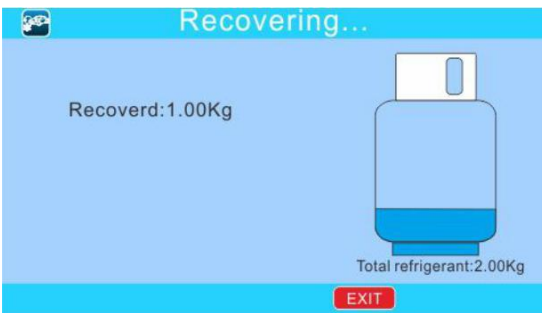
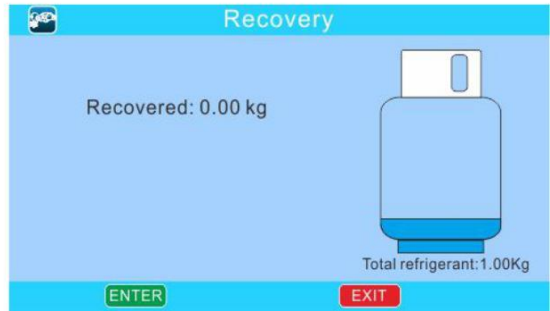

# Vacuum



Remarks: With HP leak test function, this interface is different.  
Please refer to HP leak test function in this manual.

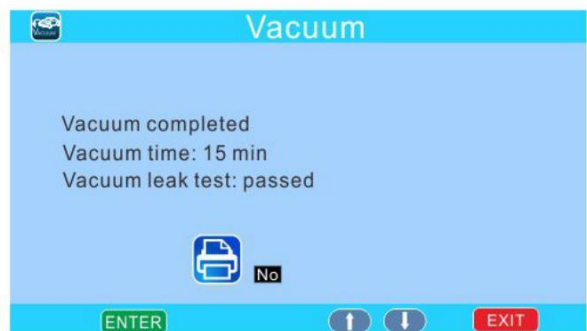
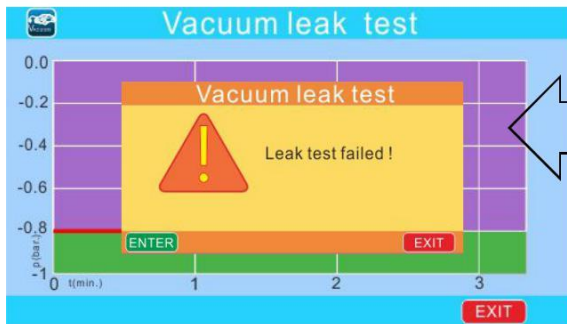
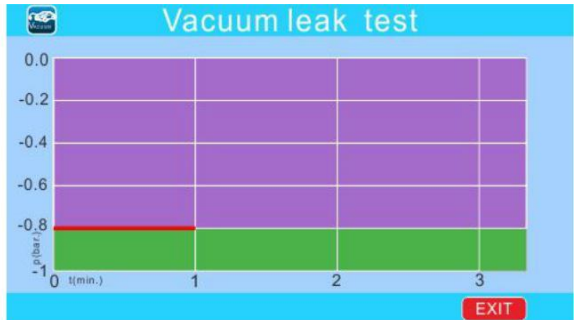
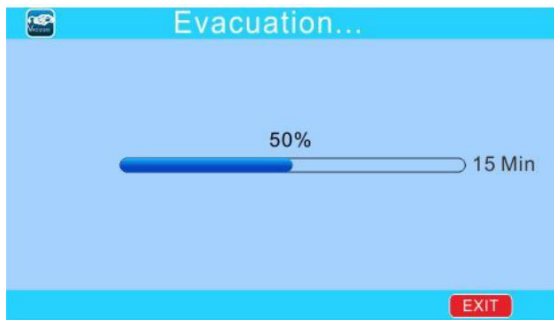
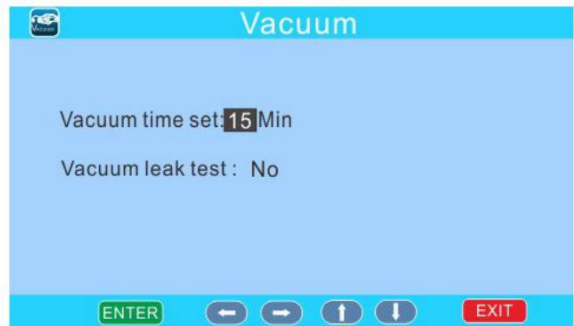

Remarks: Vacuum leak test is optional function.

# Oil injection



Remarks: With HP leak test function, this interface is different.  
Please refer to HP leak test function in this manual.

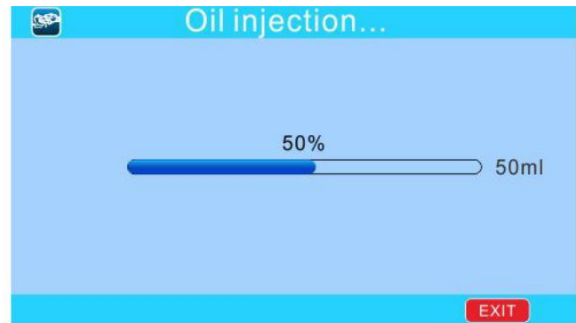
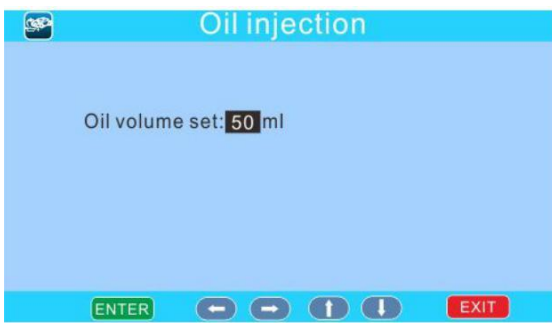
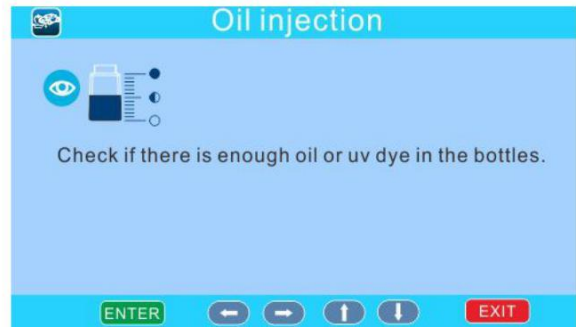

# Charge



Remarks: With HP leak test function, this interface is different.

Please refer to HP leak test function in this manual.

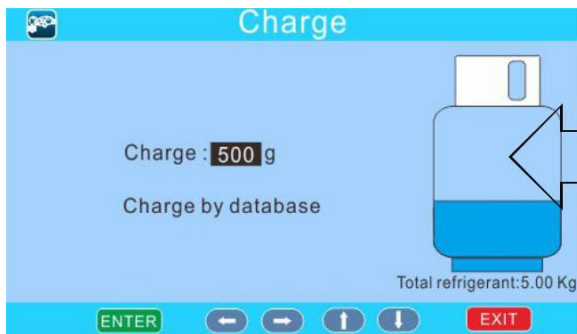

OR

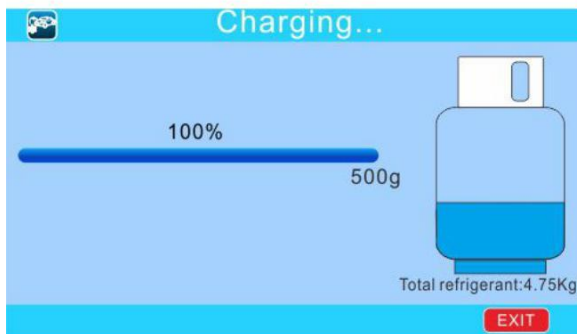

Remarks: "Hose purge" function can charge the refrigerant remained in the hoses to auto A/C system

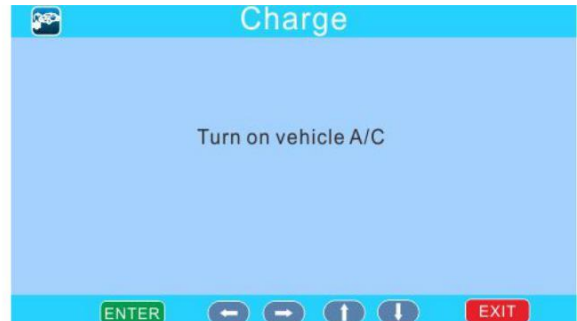
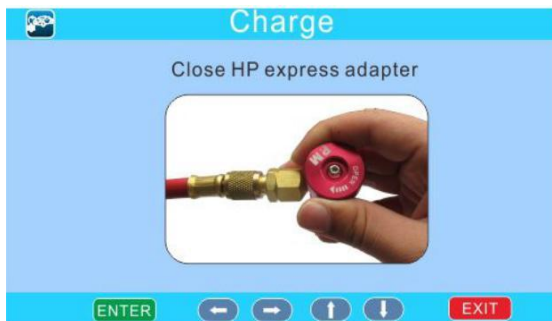

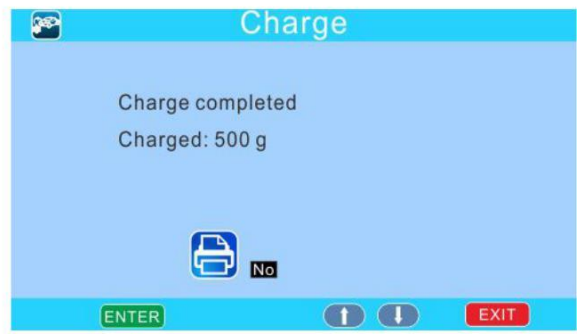
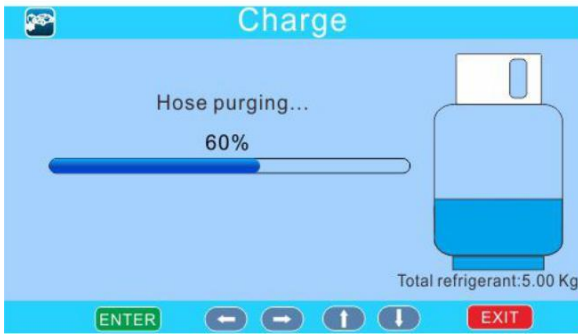

**Remarks:**

*After charge, can turn off the machine, with machine still connected to vehicle A/C, turn on the vehicle engine and A/C to watch the HP and LP gauges of the machine, to make sure that the high pressure and low pressure displayed in HP/LP gauges are in normal range of the vehicle.*

**Auto. mode**

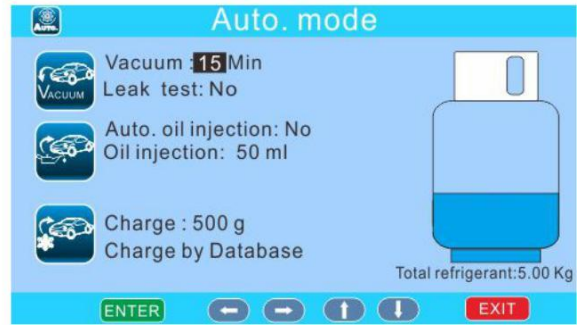

**Remarks:** With HP leak test function, this interface is different. Please refer to HP leak test function in this manual.

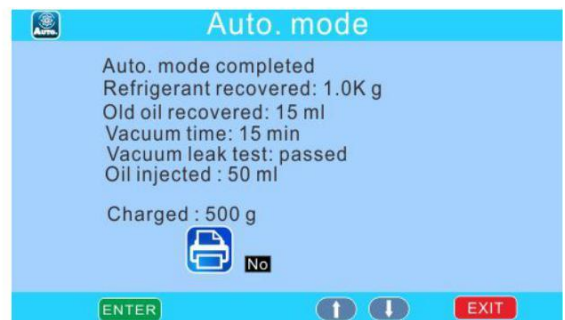
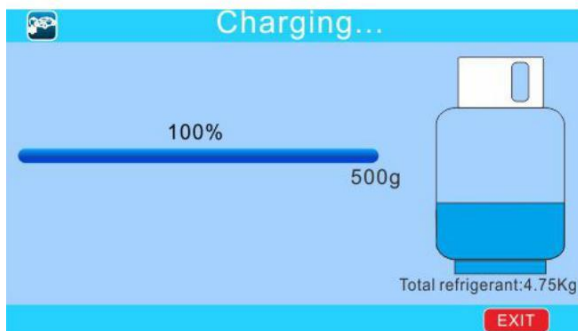
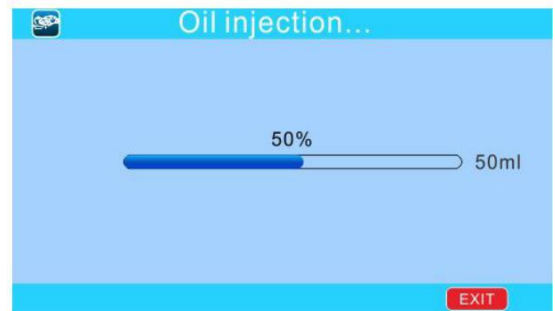
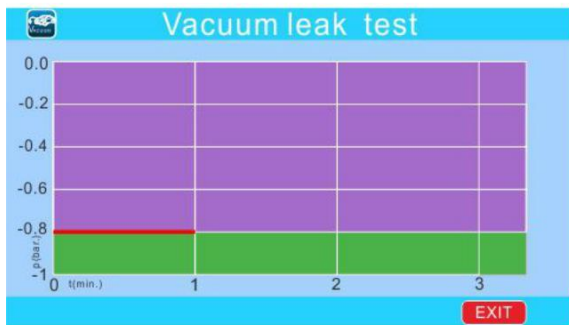
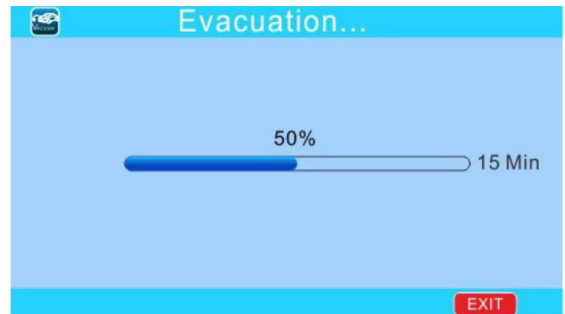
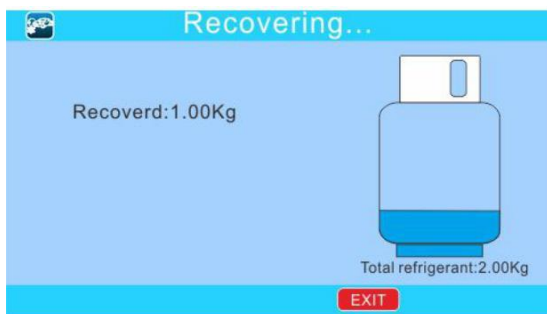

**Remarks:**

- Vacuum leak test is optional.
- Can also select “Hose purge” function, to charge the refrigerant remained in the hoses to the auto A/C system.

# HP leak test

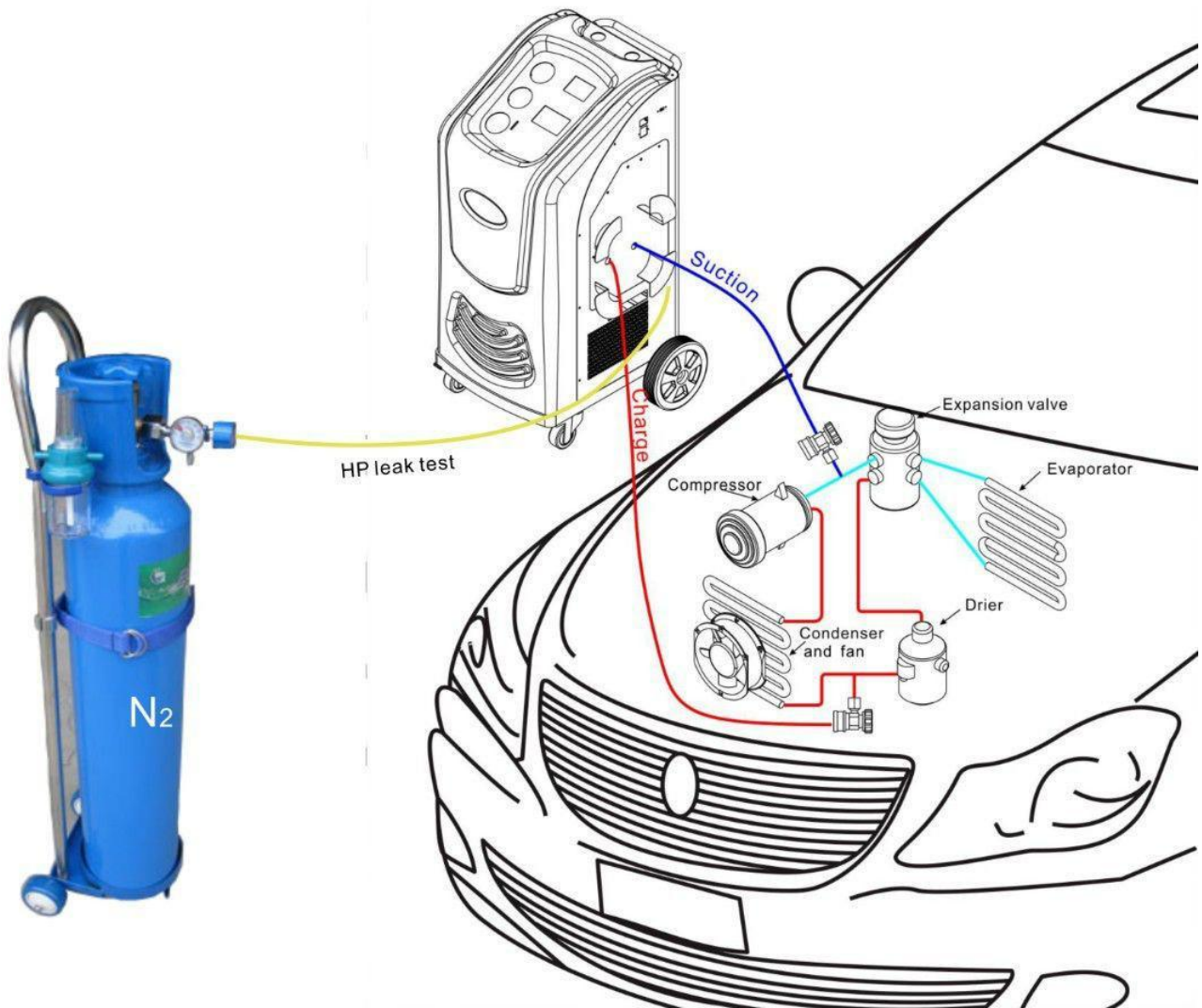

Equipment connection for HP leak test

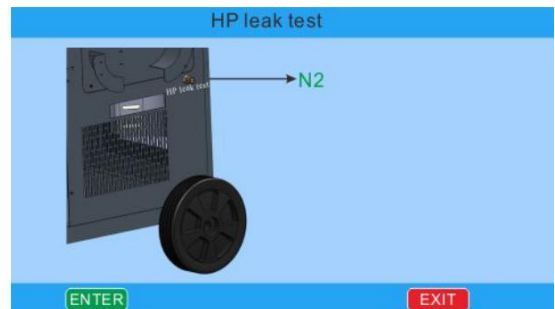

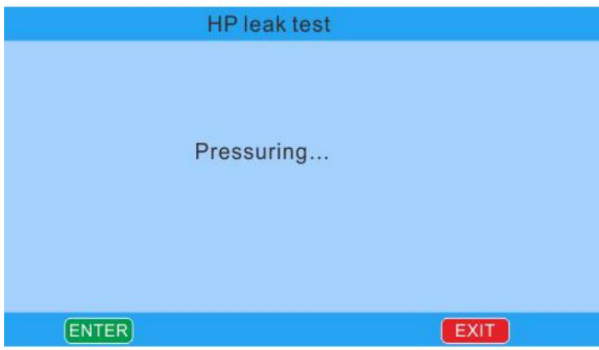

**By observing the HP and LP gauges in equipment, to determine if the AUTO A/C system has leakage. Can also use soapy water to detect the exact leak location in A/C system.**

System setting



P.W.: 111111



Calibration 1: Gas cylinder load cell Calibration



The equipment indicates to remove the gas cylinder



Remove the back cover.



Remove the gas cylinder and keep the plate empty

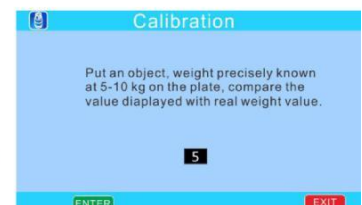

The equipment indicates to put an object of 5-10kg on the plate, and change the weight in the screen, according the object weight.

### Calibration 1: Gas cylinder load cell Calibration



Put object on the plate

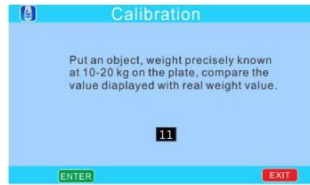

The equipment indicates to put an object of 11-15kg on the plate, and change the weight in the screen, according the object weight.



Put object on the plate



Calibration passed.

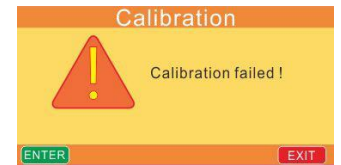

(Calibration failed, contact distributor).

### Calibration2: Oil bottle load cell calibration



The equipment indicates to remove all oil bottles.



Remove the oil bottles

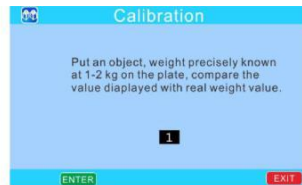

Put an object of 1-2KG on the oil bottle support, and change value in the screen, according to the object weight.

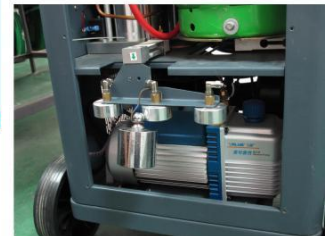

Put object on the support

### Calibration2: Oil bottle load cell calibration

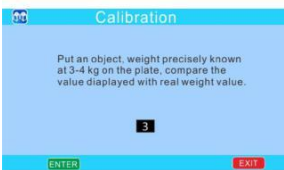

Put object of 3-4kg on the oil bottle support, and change the value in the screen according to the object weight.



Put object on the support

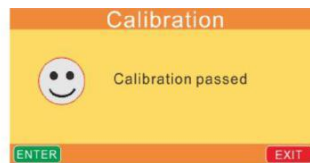

Calibration passed

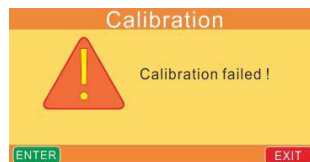

Calibration failed (Contact distributor)



**Air purge**  
R134a pressure temperature relationship

Temp (°C)	R134a (bar)	Temp (°C)	R134a (bar)	Temp (°C)	R134a (bar)
-10	2.007	10	4.145	30	7.701
-8	2.170	12	4.429	32	8.153
-6	2.344	14	4.728	34	8.625
-4	2.527	16	5.042	36	9.117
-2	2.722	18	5.371	38	9.630
0	2.928	20	5.716	40	10.164
2	3.146	22	6.078	42	10.720
4	3.376	24	6.457	44	11.299
6	3.619	26	6.853	46	11.901
8	3.876	28	7.267	48	12.526

ENTER

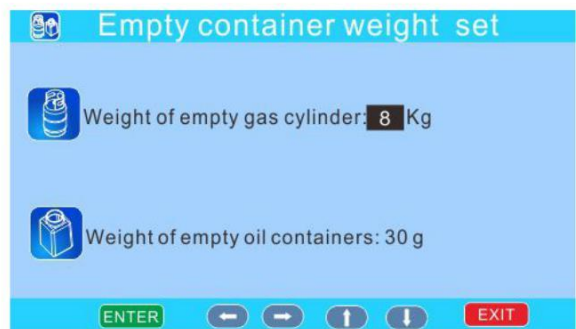
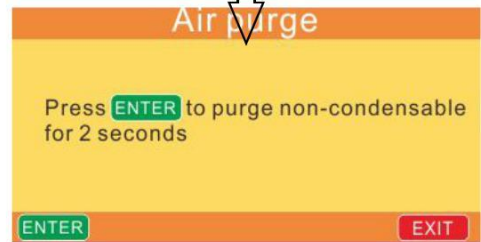

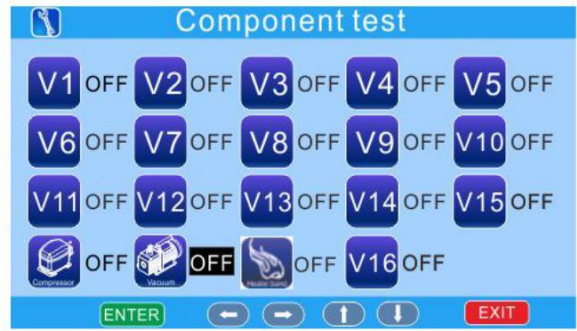

**Remarks:**

1. V11 to V15 are reserved for future development
2. V16 is available if the equipment has HP leak test function



Pressing → and ← keys, turn on the machine.

The machine displays the following message.

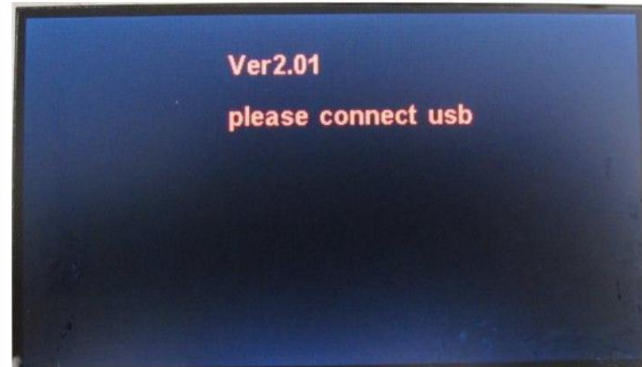

Connect the machine with PC through USB port. In PC, run USBload.exe, the PC displays the following message:

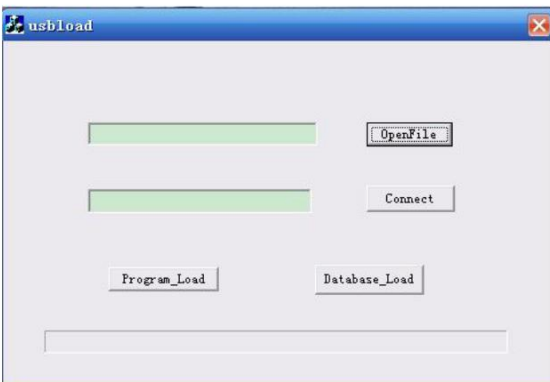

Click “OpenFile” to select update to update, e.g. file “RCC8A\_V2.01” (for main program update) or “Database\_V2.02” (for database update). Then click “Connect” the PC displays the following message

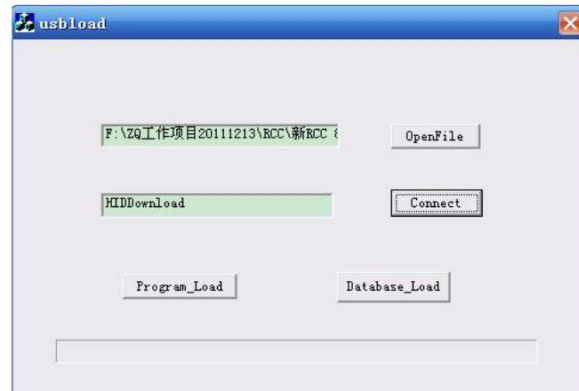

Click “Program\_load” for main program update, or click “Database\_load” for database update, the machine displays the following:



In about 1 minute, the machine displays:

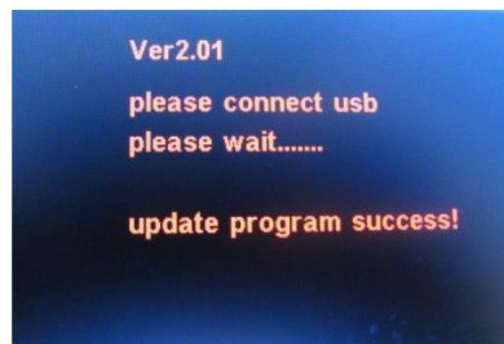

Turn off the machine and turn it on again, the machine will run the updated software.

**Maintenance reminding**

The machine permits totally 1200 operations (every recovery or vacuum counts for 1 operation, and one automatic operation counts for 2 operations) before service/maintenance is forced to make. The remaining operation number is displayed when machine turns on.



Upon 1080 operations having been made, the machine displays the following message, and users can continue using the equipment meanwhile make distributor appointment





Upon 1200 operations having been made, the machine will display the following message while the machine stops working. Service has to be made to reset service interval time again.



**Main troubleshooting**

Ma l f u n c t i o n	Reasons	So l u t i o n
Low vacuum degree	<ol style="list-style-type: none"> <li>1. Insufficient vacuum pump oil.</li> <li>2. Pump oil emulsion, dirty</li> <li>3. Pump oil inlet plugged.</li> <li>4. Leakage in pump connection.</li> <li>5. Components worn out.</li> </ol>	<ol style="list-style-type: none"> <li>1. Add oil to central line</li> <li>2. Put new oil</li> <li>3. Clean oil inlet.</li> <li>4. Check connection</li> <li>5. Put new pump.</li> </ol>
Vacuum pump inject oil.	<ol style="list-style-type: none"> <li>1. Excessive oil volume.</li> <li>2. Entrance pressure too high.</li> </ol>	<ol style="list-style-type: none"> <li>1. Discharge oil to central line</li> <li>2. Run Recovery function first.</li> </ol>
No display	<ol style="list-style-type: none"> <li>1. Fused (in Power cable connection box, or PCA)</li> <li>2. PCA burnt.</li> <li>3. Power cable loosened.</li> <li>4. LCD not work</li> </ol>	<ol style="list-style-type: none"> <li>1. Change fuses.</li> <li>2. Change PCA.</li> <li>3. Connect power cable reliably.</li> <li>4. Change LCD.</li> </ol>
Recovery does not stop	<ol style="list-style-type: none"> <li>1. Leakage in automotive A/C or equipment pipeline.</li> <li>2. Compressor not work</li> </ol> <p><i>Remarks: In winter, it is normal that recovery takes longer time.</i></p>	<ol style="list-style-type: none"> <li>1. Make leakage test. Machine leakage test with referenc to service manual.</li> <li>2. Change compressor.</li> </ol>
No change in recovery volume	<ol style="list-style-type: none"> <li>1. No refrigerant in A/C.</li> <li>2. Support screw of gas cylinder load cell not loosened.</li> <li>3. Gas cylinder load cell not work or PCA failure.</li> <li>4. For RCC-6A, hand valves not opened.</li> </ol>	<ol style="list-style-type: none"> <li>1. Stop recovery.</li> <li>2. Unsrew the support screw in the bottom of the weight sensor.</li> <li>3. Calibrate gas cylinder load cell, or change the load cell, or change PCA.</li> <li>4. Open RCC-6A HP/LP hand valves</li> </ol>
While auto A/C has refrigerant, equipment displays alarm 005	<ol style="list-style-type: none"> <li>1. Low pressure switch plug disconnected from PCA socket.</li> <li>2. For RCC-6A, hand valves closed</li> </ol>	<ol style="list-style-type: none"> <li>1. Fasten low pressure switch plug.</li> <li>2. Open RCC-6A HP/LP hand valves</li> </ol>
High pressure alarm 004 but gas cylinder gauge does not show excessive pressure value	<ol style="list-style-type: none"> <li>1. High pressure switch plug disconnected from PCA socket.</li> <li>2. Pipeline connecting compressor exit blocked.</li> </ol>	<ol style="list-style-type: none"> <li>1. Fasten high pressure switch plug.</li> <li>2. Change compressor exit side hoses.</li> </ol>
No charge or slow charge.	<ol style="list-style-type: none"> <li>1. Insufficient refrigerant in equipment</li> <li>2. System has pressure.</li> <li>3. Charge solenoid not work.</li> </ol>	<ol style="list-style-type: none"> <li>1. Add refrigerant to 5kg.</li> <li>2. Run recovery first.</li> <li>3. Check solenoid No5.</li> </ol>

<p>During recovery, vacuum pump is pressurized. After period too much oil in vacuum pump</p>	<p>The contact between solenoid valve No.4 and valve base is not well sealed.</p>	 <p>Remove solenoid No.4 from valve base, clean the solenoid valve and valve base.</p>
<p>During vacuum, there is suction in old oil bottle.</p>	<p>The contact between solenoid valve No.2 and valve base is not well sealed.</p>	 <p>Remove solenoid No.2 from valve base, clean the solenoid valve and valve base.</p>